

Varenummer: 2301077631
 Beskrivelse: E+G Håndhjul
 VR.200 FP+IR

Mål

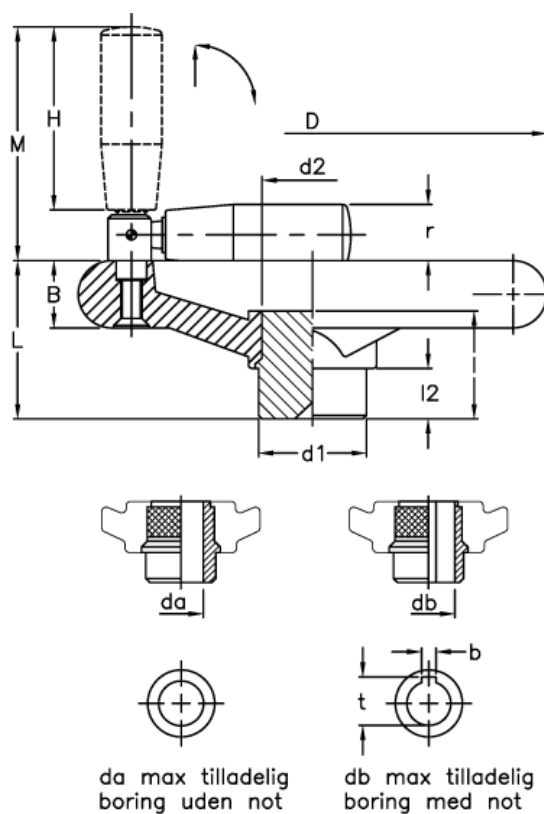

B	= 24	H	= 80	t = 24.8
b	= 6	l	= 43	
C (N*m)	= 300	L	= 56	
D	= 198	L (J)	= 16	
d1	= 40	l2	= 15	
d2	= 31	M	= 100	
da	= 26	r	= 24	
db	= 22	R	= 76	